

CTX Tandem

User Manual Maintenance and Operating Instructions

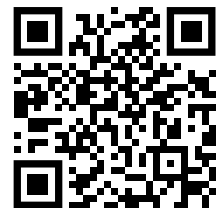
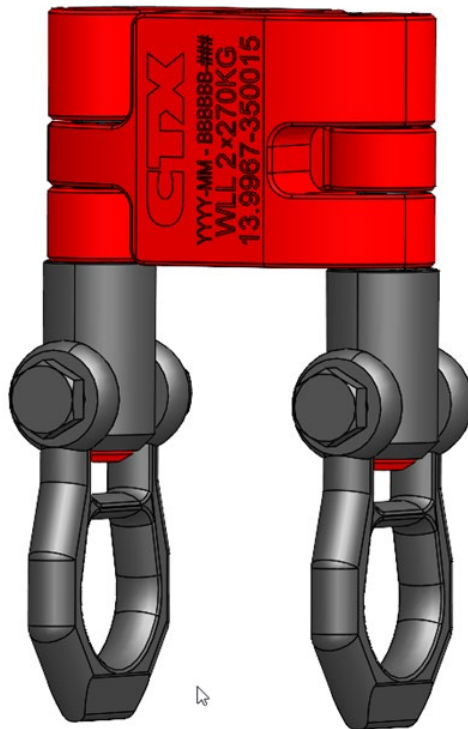

Description:	CTX Tandem Chain Ø4x12mm, Ø5x15mm, & Ø7,2x21mm
CERTEX Danmark A/S Article Number:	13.9967-350015, 13.9967-350016, & 13.9967-350017
Document:	CTX-Tandem-GM

Document:	Operating and Maintenance Instructions	Release date:	09-12-2024
Project:	CTX Tandem	Author:	MAN
Doc. No:	CTX-Tandem-GM	Doc rev:	0.3

Document revision

Version	Date	Change description	Author
0	25-01-2023	Release of document	MAN
0.1	02-10-2023	Spiral cable safety	JHA
0.2	09-12-2024	Additional safety chamfer	RTT
0.3	04-06-2026	Reference to service tool removed	JSJ

Additional Info

Additional information can be found on the webpage:

<https://www.certex.dk/en/ctx/tandem>

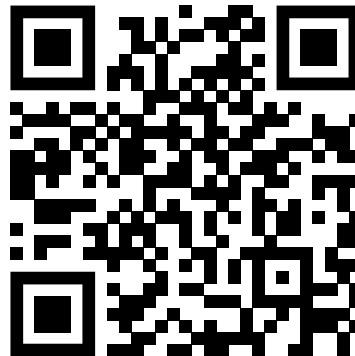

Document:	Operating and Maintenance Instructions	Release date:	09-12-2024
Project:	CTX Tandem	Author:	MAN
Doc. No:	CTX-Tandem-GM	Doc rev:	0.3

Table of Contents

DOCUMENT REVISION	2
ADDITIONAL INFO	2
1 INTRODUCTION	4
2 DEFINITIONS	5
2.1 SIGNAL WORDS	6
2.2 SAFETY SYMBOLS.....	7
2.3 DISCLAIMER.....	7
3 PRODUCT SPECIFICATION	8
3.1 PRODUCT TYPE AND DESIGNATION.....	8
3.2 DIMENSIONS AND WEIGHT	9
4 GENERAL SAFETY INFORMATION	9
5 OPERATING INSTRUCTION	11
5.1 BEFORE FIRST USE.....	11
5.1.1 <i>Chain size</i>	11
5.2 INSTRUCTIONS BEFORE USE.....	11
5.3 USE.....	12
5.4 LIMITS OF USE.....	16
5.5 STORAGE	16
5.6 DISPOSAL OF WASTE	16
6 INSPECTION AND MAINTENANCE	17
6.1 DAILY INSPECTIONS BY USER	17
6.2 ANNUAL INSPECTION BY A SKILLED PERSON	17
6.3 DEFECTS	19
7 SERVICE AND REPAIR BY SERVICE AGENT	20
7.1 SPARE PARTS	20
7.2 SERVICE AGENT ADDRESS	20
8 SPARE PARTS	21
9 DRAWING / ADDITIONAL DETAILS	22
10 LOG / NOTES	26



Document:	Operating and Maintenance Instructions	Release date:	09-12-2024
Project:	CTX Tandem	Author:	MAN
Doc. No:	CTX-Tandem-GM	Doc rev:	0.3

1 Introduction

Dear Customer.

In order to avoid damage to property and/or injury to persons, the instructions in this user manual must be observed and the equipment must be properly and adequately maintained and stored.

The instructions provided in this user manual must be read, understood, and observed by all people supervising, operating, or working with the equipment, or people in the vicinity of the equipment and/or attached accessories when in operation.

This user manual specifies a recommended minimum safety level and personnel protective equipment requirement to operate the equipment and accessories described in this user manual. However, it must be noted that any additional safety rules and recommendations specified by legislation, authorities or operators' company must be complied with.

It is important that user instruction manuals for all accessories are also read, understood, and complied with.

This user manual must be retained with the equipment at all times.

In the case of damage and/or functional disturbance due to incorrect handling, as a result of the fact that the user manual instructions were not complied with, the manufacturer cannot be held responsible or liable.

If difficulties or queries should arise when using the lifting equipment, please contact the manufacturer directly:

**CERTEX Danmark A/S
Trekanten 6-8
DK - 6500 Vojens
Denmark
Phone no.: (45) 74 54 14 37
www.certex.dk/**

Document:	Operating and Maintenance Instructions	Release date:	09-12-2024
Project:	CTX Tandem	Author:	MAN
Doc. No:	CTX-Tandem-GM	Doc rev:	0.3

2 Definitions

For this instruction user manual, the following definitions apply:

- **danger zone¹** Means any zone within and/or around machinery in which a person is subject to a risk to their health and safety.
- **guard¹** Part of a product specially used to provide protection by means of a physical barrier.
- **harm²** Physical injury or damage to the health of people or damage to property or the environment.
- **hazard¹** Means a potential source of injury or damage to health.
- **instruction (for use)²** Information by the producer of a product for the safe and efficient use of the product.
- **instruction manual²** Any applicable means for the transfer of information containing instructions.
- **intended use¹** The use of machinery in accordance with the information provided in the user manual.
- **lifting accessories¹** A linking device, part, chain, sling, or another connection part which is attached to the lifting device for connection to the load. These must be independently marked if not forming a part of the full assembly.
- **maintenance²** Combination of all technical and administrative actions intended to retain an item or product in a usable and safe condition, in which it can perform the intended design function. This includes repairing, adjusting, and cleaning.
- **manual²** A document containing all relevant user information.
- **marking¹** Legible sign or inscription for the identification of the type of a component or device, attached by the manufacturer of the component or device and the designation of certain features of the product for its safe use.
- **modification²** Change carried out on a product in order to alter its intended use, and /or a revision of the instructions after a modification of a product,
- **operating personnel / operator¹** A person entrusted by the owner of the machine with operating, maintaining, cleaning, repairing, or moving the equipment. This person must be trained by the owner in accordance with the tasks to be performed.
- **risk¹** Combination of the probability and the degree of an injury, or damage to health that can arise in a hazardous situation.
- **skilled person²** A skilled person is an individual with relevant technical education, training, or experience to enable perceiving risks and avoiding hazards occurring during use of a product.



Document:	Operating and Maintenance Instructions	Release date:	09-12-2024
Project:	CTX Tandem	Author:	MAN
Doc. No:	CTX-Tandem-GM	Doc rev:	0.3

- specification² A document that states requirements, functionally related characteristics, processes, or a product shall possess
- supervisor¹ A supervisor is an appointed responsible person for the productivity, training, and actions of a small group of employees.
- WLL Working Load Limit – This is the maximum load that the non-fixed load lifting attachment is designed to lift under the conditions specified by the manufacturer. (EN13155).
- PPE Personal Protective Equipment
- N/A Not applicable.

Ref: 1) Directive 2006/42/EC
2) EN 82079-1

2.1 Signal words

This User Manual classifies the safety information and precautions into four categories of “DANGER”, “WARNING”, “CAUTION” and “NOTICE”.

 DANGER
Indicates an imminently hazardous situation which, if not avoided, will result in death or serious injury.
 WARNING
Indicates a potentially hazardous situation which, if not avoided, could result in death or serious injury.
 CAUTION
Indicates a potentially hazardous situation which, if not avoided, could result in minor or moderate injury.

NOTICE
Indicates information considered important, but not hazard-related (e.g., messages relating to property damage).

 **INFORMATION** Note with useful information, tips, and recommendations.

Document:	Operating and Maintenance Instructions	Release date:	09-12-2024
Project:	CTX Tandem	Author:	MAN
Doc. No:	CTX-Tandem-GM	Doc rev:	0.3

2.2 Safety symbols



Mandatory

A blue circle with a white symbol within. This indicates a specific course of action that must be taken.



Warning!

A yellow triangle with a black border. The black symbol within denotes the warning of a hazard.



Prohibition

A red circular band with a diagonal crossbar on a white background. The black symbol within denotes that certain behaviour is prohibited.

2.3 Disclaimer

- CERTEX Danmark A/S shall not be liable for any damage incurred thereof due to natural disasters such as fire, earthquake, and thunderbolt, conduct by the third party, accident, wilful conduct or negligence by a customer, erroneous use and other use exceeding the operational condition.
- CERTEX Danmark A/S shall not be liable for any incidental damage due to the use or non-use of the product such as the loss of business profit, suspension of business and damage of the lifted load.
- CERTEX Danmark A/S shall not be liable for any damage arising from the negligence of the contents in the Operator's and Maintenance Manual and the use of the product exceeding the scope of its specification.
- CERTEX Danmark A/S shall not be liable for any damage arising from the malfunction due to the combination of the product with other devices in which CERTEX Danmark A/S is not concerned.
- CERTEX Danmark A/S shall not be liable to supply the spare parts for the product for which it has passed for 10 years since the discontinuation of the product.

Document:	Operating and Maintenance Instructions	Release date:	09-12-2024
Project:	CTX Tandem	Author:	MAN
Doc. No:	CTX-Tandem-GM	Doc rev:	0.3

3 Product specification

3.1 Product Type and designation

The presented User Manual covers the use and maintenance of the CTX Tandem. The tools are identified as item number 13.9967-350015, 13.9967-350016, and 13.9967-350017.

The CTX Tandem is intended for adding attachments to a hanging hoist chain to lift many separate loads with weight not exceeding WLL 270kg on each lifting eye.

The CTX Tandem is designed with two Clamps (1) and two self-locking Lifting Pins (2).

See Table 1 and Figure 3.

	Part	Drawing no.
1	Clamp, marked.	13.9967-3500XX-001*
2	Clamp, unmarked.	13.9967-3500XX-002*
3	Self-locking lifting pin	99.DK34-000975
4	Spiral cable	13.9967-350013-SPCA

Table 1: The CTX Tandem parts * 'XX' is either 15, 16, or 17.

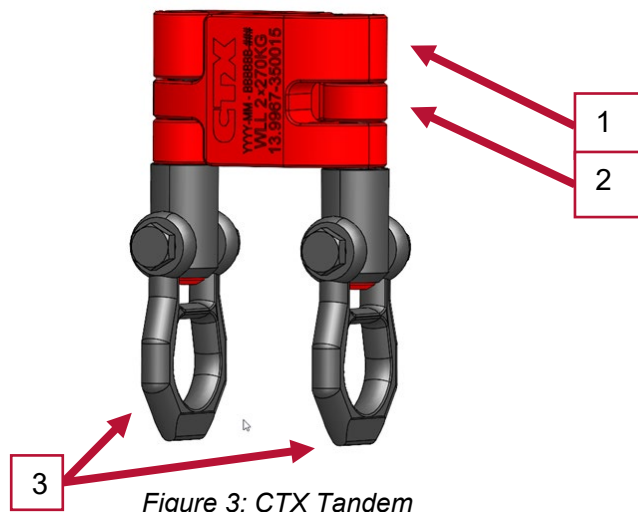

Figure 3: CTX Tandem

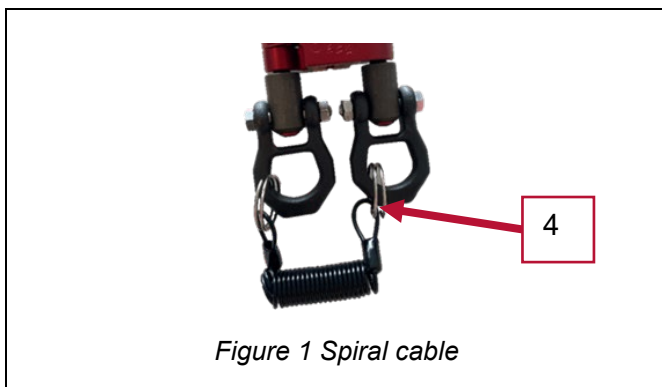

Figure 1 Spiral cable

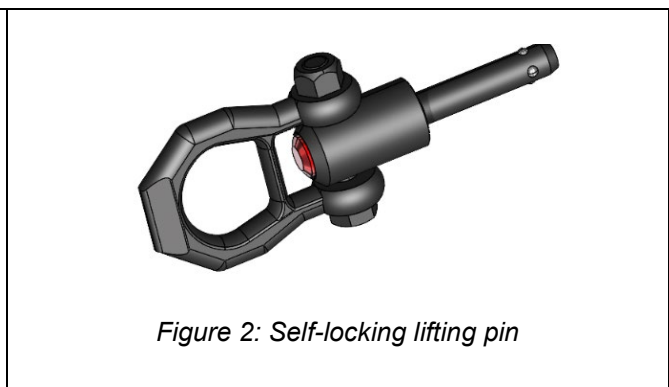

Figure 2: Self-locking lifting pin

Document:	Operating and Maintenance Instructions	Release date:	09-12-2024
Project:	CTX Tandem	Author:	MAN
Doc. No:	CTX-Tandem-GM	Doc rev:	0.3

The CTX Tandem Tool has been designed in accordance with Directive 2006/42/EC, EN13155 and ASME BTH-1.

The tool is manufactured according to Directive 2006/42 / EC and tested with a static test coefficient of 1.5.

3.2 Dimensions and Weight

Dimensions, W x L x H *	49mm x 82mm x 136mm
Weight *	1 kg

* - without Bumper Ring

4 General safety information

Wear all required Personal Protective Equipment (PPE) when using CTX Tandem.





Mandatory! Wear safety footwear
Wear safety footwear all the time when using equipment to prevent objects from damaging your feet.

 **WARNING**



All applicable local, national and international health & safety regulations and PPE requirements **MUST** be followed in addition to CERTEX Danmark A/S safety recommendations.

 **DANGER**





- Always ensure that load is correctly secured to the CTX Tandem.
 - See section 5.3 Use
- Never exceed the specified WLL.
- Never stand, work, or pass under a hanging load, and when lowering the lifting device, the operator must ensure that any attached lifting accessories do not swing into personnel in the danger zone.
- When lowering the load, the operator must ensure that it is on a secure base, so that it will not fall or rotate, when the lifting device is disconnected and removed.
- During lifting, if there is a potential crush risk between the lifting equipment, load, machines, building parts etc., no personnel or operators may remain in the danger zone.
- When working outside additional precautions must be taken due to weather conditions that can affect safety of the work.

 **WARNING**

Document:	Operating and Maintenance Instructions	Release date:	09-12-2024
Project:	CTX Tandem	Author:	MAN
Doc. No:	CTX-Tandem-GM	Doc rev:	0.3

	<ul style="list-style-type: none"> • All lifting equipment that is attached to the CTX Tandem or used in the lifting operation, must be CE marked and approved for the load to be lifted. • The lifting device may never be left unattended during a lifting operation, and the load must be secured before leaving the danger zone. • Never use the CTX Tandem with visible defects or deficiencies, such as wear, distortion, rust damage or similar.
---	--

	 WARNING
	<ul style="list-style-type: none"> • The CTX Tandem must never be used to transport persons or other living things.

	 WARNING
	<ul style="list-style-type: none"> • Self-locking lifting pins are not suited for the continuous rotation of the load. • Soilings (e.g., grits and grinds, oil and emulsion deposits, dust) can affect the functioning of the self-locking pins. Using damaged self-locking lifting pins can be perilous. • Before any use, carefully inspect the self-locking lifting pins (i.e., deformities, breaks, rips, damages, missing balls, corrosion, unlocking function). Damaged self-locking pins must be withdrawn from service immediately.

Document:	Operating and Maintenance Instructions	Release date:	09-12-2024
Project:	CTX Tandem	Author:	MAN
Doc. No:	CTX-Tandem-GM	Doc rev:	0.3

5 Operating instruction

5.1 Before first use

5.1.1 Chain size

When using the CTX Tandem, the usage of a correct chain size must be ensured. The suitable chain size is indicated on top of the unmarked clamp. The clamp is marked for example 5 referring to chain sizes. The number is visually inspected as seen on Figure 4: Chain size. See Section 5.4 Limits of use for details on chains.

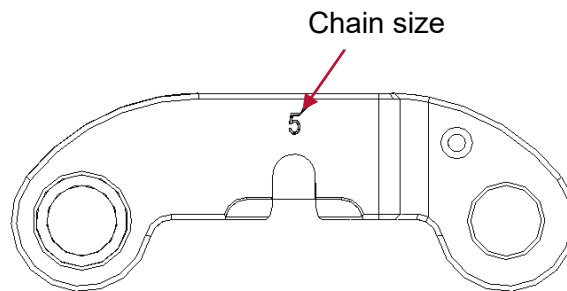

Figure 4: Chain size



5.2 Instructions before use

Before use of the CTX Tandem, the condition of the tool must be checked. Make sure that the surface of the CTX Tandem is clean and free of any object.

Visually the CTX Tandem must seem to be in good condition and safe to use. No apparent deformation, damage, flaw, cracks, or corrosion may be observed. Carefully inspect the self-locking lifting pins for deformities, breaks, rips, damages, missing balls, corrosion and unlocking function. Ensure that the pin and parts are free from debris, grit or contaminants that can limit the functionality of the locking mechanism.

If there are found any faults in the CTX Tandem, the equipment must be removed from service.

Do not use it until a competent person has fully inspected the CTX Tandem, and confirmed it is safe to use.

	 WARNING
	<ul style="list-style-type: none"> • No modifications, alterations to the CTX Tandem should be made without prior advice and written approval from CERTEX Danmark A/S. • Unauthorised modifications, alterations, and use of non-original spare parts could result in death or serious injury.

Document:	Operating and Maintenance Instructions	Release date:	09-12-2024
Project:	CTX Tandem	Author:	MAN
Doc. No:	CTX-Tandem-GM	Doc rev:	0.3

5.3 Use

The CTX Tandem clamps are attached around a hoist chain, and the clamps are secured with the self-locking lifting pins, as seen on figure 4.

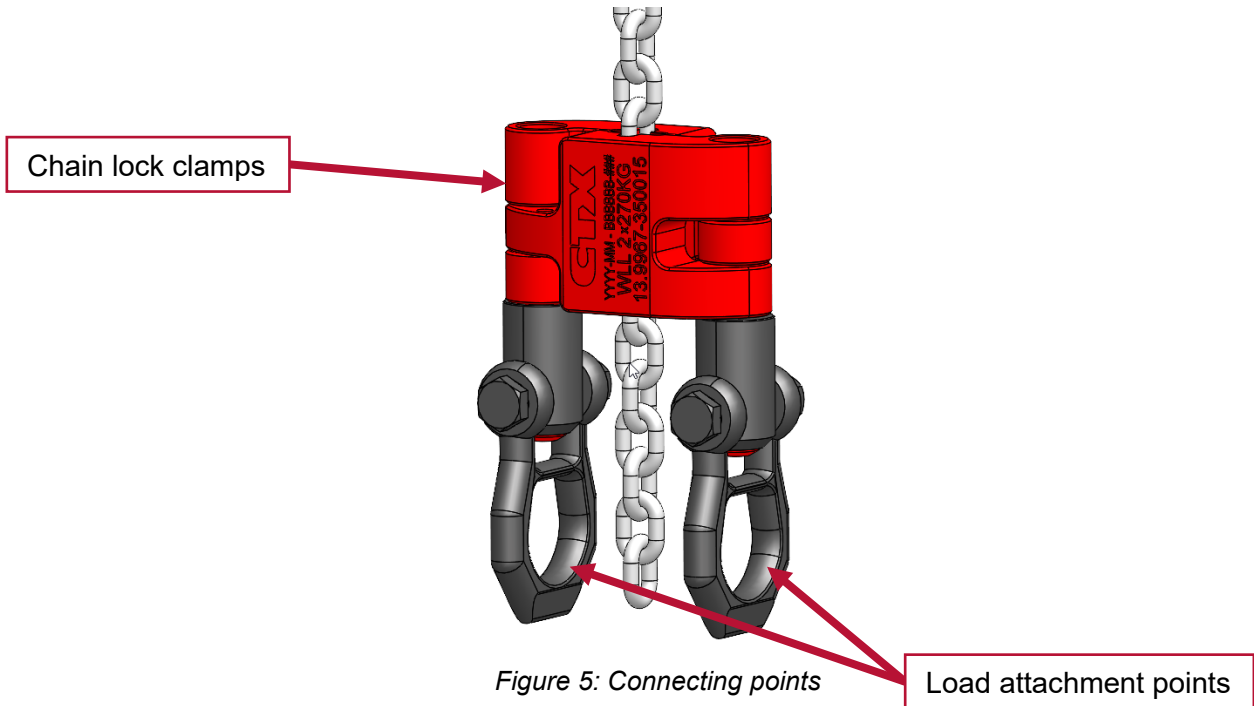

Assembly instructions:

<p>The diagram shows two red clamps being joined together. Two red arrows point from labels 'Balls' and 'Button (A)' to the corresponding parts on the clamps. The 'Balls' label points to the spherical locking mechanism, and the 'Button (A)' label points to the release button on the side of the clamp.</p>	<ol style="list-style-type: none"> 1. Assemble two clamps using one of the self-locking safety pins. To release the balls in self-locking safety pin, press button (A). To lock the balls, release button (A). <p>NB: Pull firmly in self-locking pin to make sure its locked in lower position.</p>
---	--

Document:	Operating and Maintenance Instructions	Release date:	09-12-2024
Project:	CTX Tandem	Author:	MAN
Doc. No:	CTX-Tandem-GM	Doc rev:	0.3

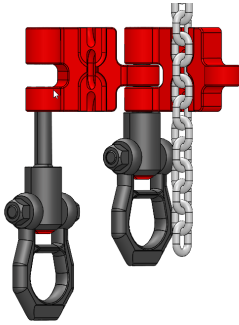
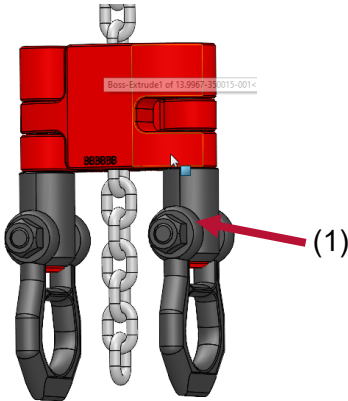
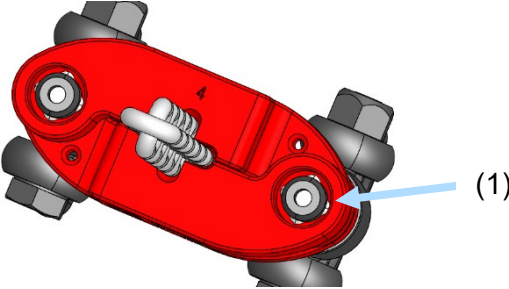
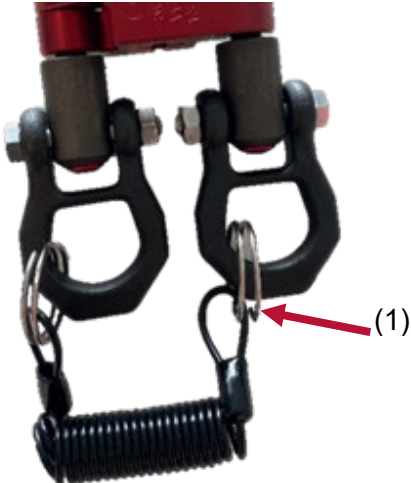
	<p>2. Place the hoist chain in the recess of the clamp. Make sure that the self-locking safety pin eye is pointing downwards.</p>
	<p>3. Lock the chain using the second self-locking safety pin (1). To release the balls in self-locking safety pin, press button (A). To lock the balls, release button (A).</p>
	<p>4. Check visually if the self-locking safety pin balls (1) are locked properly in the clamp hole. And that the clamp hole is the external one.</p> <p>NB: Pull in each lifting point to make sure the self-locking pins are locked safely.</p> <p>Always make sure to use the end stopper to avoid damaging the hoist.</p>
	<p>5. The optional spiral cable (1) must be mounted on the bottom part of the self-locking safety pin.</p> <p>NB: Check visually if the spiral cable is mounted as illustrated on the picture to the left.</p>



Document:	Operating and Maintenance Instructions	Release date:	09-12-2024
Project:	CTX Tandem	Author:	MAN
Doc. No:	CTX-Tandem-GM	Doc rev:	0.3



Document:	Operating and Maintenance Instructions	Release date:	09-12-2024
Project:	CTX Tandem	Author:	MAN
Doc. No:	CTX-Tandem-GM	Doc rev:	0.3

The load is attached to the CTX Tandem through suitable approved lifting accessories to the attachment points – lifting eyes.

	⚠ CAUTION
	The load should be symmetrically distributed over both lifting eyes to ensure that the centre of gravity of the total load is placed on the axis of the hoist chain

	⚠ WARNING
	<ul style="list-style-type: none"> The button (A) of the Safety Pin is locked after springing back to the initial position by means of the spring resistance. Do not operate the button when the load is attached. Do not mount the spiral cable, or anything else, close to the button (A) on the Self-locking lifting pin. <div style="text-align: center;">  </div>

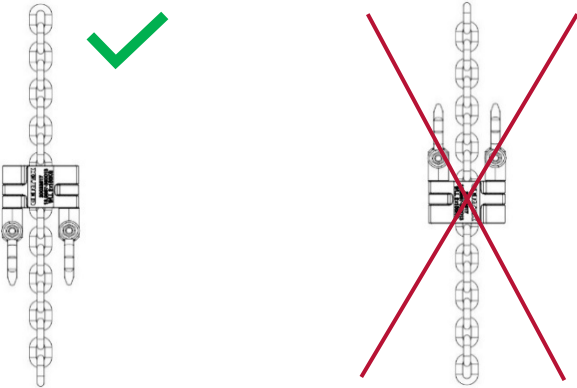
	⚠ WARNING
	<ul style="list-style-type: none"> Make sure that the Safety Pin eyes are pointing downwards. Never lift the load with the Safety Pins eyes on the top of the CTX Tandem. <p>NB: Pull in each lifting point to make sure the self-locking pins are locked safely.</p> <div style="text-align: center;">  </div>

Document:	Operating and Maintenance Instructions	Release date:	09-12-2024
Project:	CTX Tandem	Author:	MAN
Doc. No:	CTX-Tandem-GM	Doc rev:	0.3

5.4 Limits of use

The CTX Tandem has limitations in use due to its design. It is designed for maximal 16000 loading cycles acc. EN13155.

Suitable for chains:

Chain size	Ø4x12 mm	Ø5x15 mm	Ø7.2x21 mm
Limits D	Ø3.8 to Ø4.2 mm	Ø4.8 to Ø5.2mm	Ø7.0mm to Ø7.4mm
Limits L	11 mm to 13 mm	14 mm to 16 mm	20 mm to 22 mm

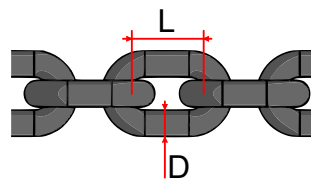

Wind conditions must allow conducting the lifting operation safely.

Temperature Range: -20°C to 60°C.

CTX Tandem parts and chain must be free from ice, dirt, debris etc. for safe lifting. If used in environments with heavy corrosion, the tool shall be cleaned thoroughly after every use and preserved in a suitable packaging, to avoid corrosion of steel and aluminium parts.

If utilized in temperatures below +5°C, it must be ensured that no moisture or water can freeze and cause the mechanisms in the self-locking safety pin is limited.

5.5 Storage

When not used the CTX Tandem should always be stored indoors in a clean and dry environment and free of any chemical interaction to reduce the risk of corrosion.

5.6 Disposal of waste

The CTX Tandem produces no waste.

All metal parts must be sent to a recycling centre or returned to the manufacturer for disposal.

Document:	Operating and Maintenance Instructions	Release date:	09-12-2024
Project:	CTX Tandem	Author:	MAN
Doc. No:	CTX-Tandem-GM	Doc rev:	0.3

6 Inspection and maintenance

The CTX Tandem must be unloaded before any inspection are carried out.

6.1 Daily inspections by user

The CTX Tandem must be inspected by the user prior to use or at least once a month.

Maintenance Inspection – Checklist		
Item	Check method	Criteria
1. The overall CTX Tandem	Visual	<ul style="list-style-type: none"> The overall impression of the CTX Tandem must seem to be in good condition and safe to use. No apparent deformation, damage, flaw, or cracks. No corrosion is visible.
2. Inspection of the self-locking safety pins	Visual	<ul style="list-style-type: none"> No visible deformation, wear, or cracks are presented. No missing and damaged balls, corrosion, or screw union damages at the shackle are presented. No corrosion is visible.
	Manually	<ul style="list-style-type: none"> The locking device of the balls has to lock by a spring mechanism. The shackle moves freely.
3. Spiral cable	Visual	<ul style="list-style-type: none"> No visible deformation, wear, or cracks are presented. No missing and damaged balls, corrosion, or screw union damages at the shackle are presented. No corrosion is visible.

If utilized in temperatures below +5°C, it must be ensured that no moisture or water can freeze and cause the mechanisms in the self-locking safety pin to be limited.

6.2 Annual inspection by a skilled person

CTX Tandem must be thoroughly inspected and serviced by a skilled person every twelve months.

The service inspection must only be completed by suitably qualified personnel or lifting equipment technicians, who have the suitable required training.

Document:	Operating and Maintenance Instructions	Release date:	09-12-2024
Project:	CTX Tandem	Author:	MAN
Doc. No:	CTX-Tandem-GM	Doc rev:	0.3

Maintenance Inspection – Checklist		
Item	Check method	Criteria
1. The overall CTX Tandem	Visual	<ul style="list-style-type: none"> The overall impression of the CTX Tandem must seem to be in good condition and safe to use. No apparent deformation, damage, flaw, or cracks. No corrosion or indents visible
	Measure	<ul style="list-style-type: none"> Diameter of bore for self-locking pins is between Ø10.00 and Ø10.11mm. <p>NB: Usage of the special service tool is preferred. Item number: 13.9967-350013-01</p>
2. Inspection of the self-locking safety pins	Visual	<ul style="list-style-type: none"> No visible deformation, wear or cracks are presented. No missing and damaged balls, corrosion, screw union damages at the shackle are presented. No corrosion or indents visible.
	Manually	<ul style="list-style-type: none"> The locking device of the balls has to lock by a spring mechanism. The shackle moves freely.
3. Inspection of chain grooves	Visual	<ul style="list-style-type: none"> No visible deformation, wear or cracks are presented. No corrosion or indents visible.
	Measure	<ul style="list-style-type: none"> None of the flat grooves must exceed the centreline of the clamp (24 mm from top or bottom).
4. Spiral cable	Visual	<ul style="list-style-type: none"> No visible deformation, wear or cracks are presented. No missing and damaged balls, corrosion, screw union damages at the shackle are presented. No corrosion or indents visible.

Document:	Operating and Maintenance Instructions	Release date:	09-12-2024
Project:	CTX Tandem	Author:	MAN
Doc. No:	CTX-Tandem-GM	Doc rev:	0.3

6.3 Defects

If there are found any faults in the CTX Tandem, the defective item/tool should be taken out of service.

NOTE	
No modifications, alterations to the CTX Tandem should be made without prior advice and written approval by CERTEX Danmark A/S.	

	! WARNING
Unauthorised modifications, alterations, and use of non-original spare parts could result in death or serious injury.	

Document:	Operating and Maintenance Instructions	Release date:	09-12-2024
Project:	CTX Tandem	Author:	MAN
Doc. No:	CTX-Tandem-GM	Doc rev:	0.3

7 Service and repair by Service agent

7.1 Spare parts

Only spare parts approved by CERTEX Danmark may be used.

7.2 Service agent address

CERTEX Danmark A/S
Trekanten 6-8
DK - 6500 Vojens
Denmark
Phone no.: (+45) 74 54 14 37

info@certex.dk

If located outside Denmark a nearby address is found on: <https://www.certex.dk/en/offices>

The CTX Tandem must be serviced and maintained as specified by the manufacturer or after updated regulations as required.

Document:	Operating and Maintenance Instructions	Release date:	09-12-2024
Project:	CTX Tandem	Author:	MAN
Doc. No:	CTX-Tandem-GM	Doc rev:	0.3

8 Spare Parts

Component	Part Number	Qty	Picture
Clamp Marked	13.9967-3500XX-001	1	
Clamp Unmarked	13.9967-3500XX-002	1	
Lifting Pin Self Locking	99.DK34-000975	2	
Spiral cable	13.9967-350013-SPCA	1	

* 'XX' is either 15, 16, or 17.

Document:	Operating and Maintenance Instructions	Release date:	09-12-2024
Project:	CTX Tandem	Author:	MAN
Doc. No:	CTX-Tandem-GM	Doc rev:	0.3

9 Drawing / Additional details



Document:	Operating and Maintenance Instructions	Release date:	09-12-2024
Project:	CTX Tandem	Author:	MAN
Doc. No:	CTX-Tandem-GM	Doc rev:	0.3



Document:	Operating and Maintenance Instructions	Release date:	09-12-2024
Project:	CTX Tandem	Author:	MAN
Doc. No:	CTX-Tandem-GM	Doc rev:	0.3



Document:	Operating and Maintenance Instructions	Release date:	09-12-2024
Project:	CTX Tandem	Author:	MAN
Doc. No:	CTX-Tandem-GM	Doc rev:	0.3



